

**INSTRUCTION**  
on  
**Installation, Care and Operation**  
of the  
**CHANDLER & PRICE**  
**CRAFTSMAN AUTOMATIC UNIT**

10 x 15 and 12 x 18

1946

**THE CHANDLER & PRICE COMPANY**  
**CLEVELAND, OHIO, U. S. A.**

Printed in U. S. A.



## INTRODUCTION

---

**I**N this book of instructions it is our purpose to outline as briefly and clearly as possible the usual methods followed in the installation, care and operation of the Chandler & Price 10x15 and 12x18 Craftsman Automatic Units.

The procedure and methods suggested have been compiled by competent demonstrators and operators and represent the general practice in printing plants where these units have greatly increased the quality of the printing and the profits to the owners.

On account of conditions of an unusual nature sometimes present in separating, feeding, registering and printing, it may be that certain information will not be found in this book. As always, however, it can be said that it is the policy of this company to assist the operators and owners of Chandler & Price equipment with their special problems to the end that the equipment may render satisfactory and efficient service.

THE CHANDLER & PRICE COMPANY

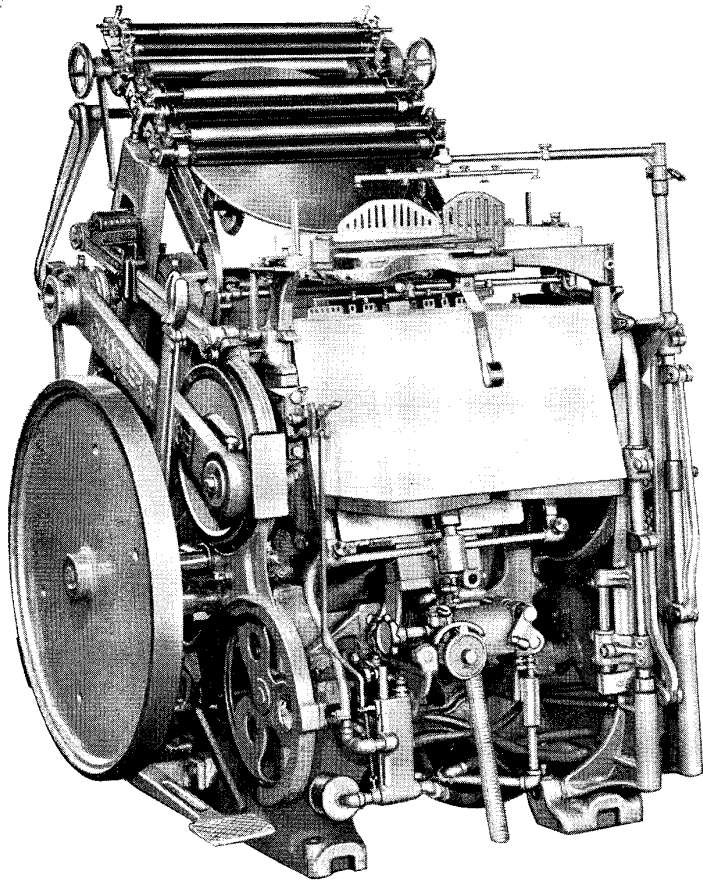

*The Chandler & Price Craftsman  
Automatic Unit 12 x 18  
shown here with Micromatic Ink  
Distributor placed on Units  
Numbered RD 1649 and up*

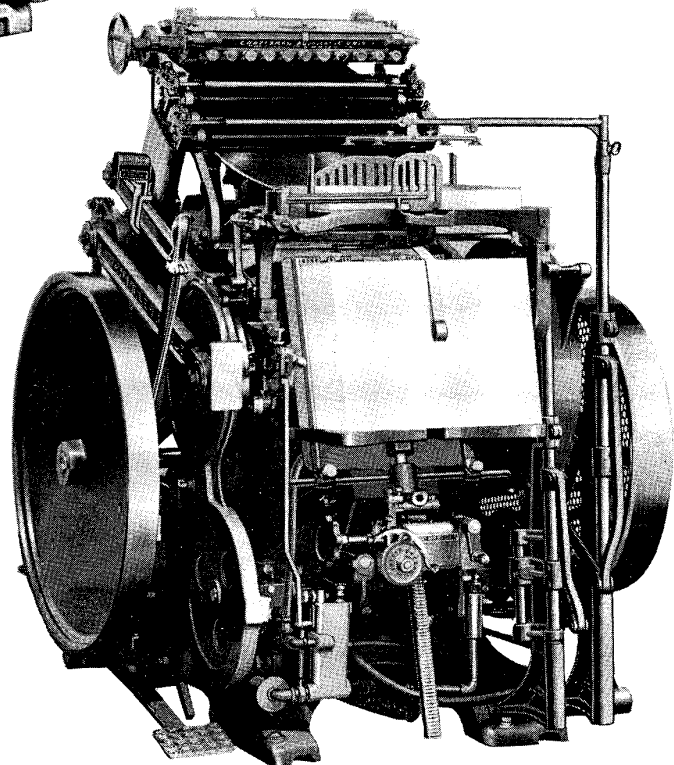

*The Chandler & Price Craftsman  
Automatic Unit 10 x 15*

## SPECIFICATIONS

	10 x 15 UNIT	12 x 18 UNIT
Chase dimensions:		
Inside . . . . .	10" x 15"	12" x 18"
Outside . . . . .	12½" x 17"	15¾" x 20½"
Maximum size of sheet . . . . .	11" x 15½"	13" x 19"
Minimum size of sheet . . . . . (*88 Card)	1⅞" x 3⅜"	1⅞" x 3⅜"
Platen—dimensions . . . . .	11¼" x 18⅛"	13⅜" x 21¾"
Disc—diameter . . . . .	17¼"	20⅝"
Flywheel:		
Diameter . . . . .	30"	30"
Width of face . . . . .	2¼"	2¼"
Form rollers (4 to set) should be cast—diameter . . . . .	1¾"	2"
Fountain roller (1) should be cast—diameter . . . . .		1¾"
Roller trucks—standard diameter . . . . .	1⅙"	1⅙"
Revolutions of crankshaft to one impression . . . . .	6	7
R.P.M. of crankshaft for maximum impressions per hour . . . . .	350	350
Press pulley—diameter . . . . .	22"	22"
Impressions per hour as high as . . . . .	3500	3000
Horsepower recommended . . . . .	1½	1½
Floor space . . . . .	45" x 60"	50" x 65"
Opening through which unit will pass—regular shipment . . . . .	47"	48½"
Weights:		
Net weight—lbs. . . . .	2675	3350
Crated for shipment—lbs. . . . .	3000	3600

## WHEN ORDERING PARTS

---

Always give the serial number of the unit which is found stamped on the bed of the press in the upper left-hand corner.

Always give the size of the press, part number, and the name and description of the part wanted.

Always state the definite mode of transportation, whether Air Mail—Express—Parcel Post—Freight.

When ordering by wire, use Code words listed in the left-hand column of Part List, specifying quantity of each part wanted. The Code word will indicate to us the number and the name of the part.

Parts are shipped f.o.b. factory and any prices listed are subject to change without notice.

In practically all cases, parts ordered will be shipped from the factory the same day the order is received.

Too much information is always better than not enough. A close observance of the above suggestions will eliminate the possibility of error and will expedite service.

## INSTALLATION

The Unit was shipped from the factory with a minimum number of parts removed. While unpacking, each individual part should be examined in order to become familiar with its particular use on the Unit, as at some time or other a job will come along for which this or that part was included in the equipment.

After the parts have been examined thoroughly, clean the grease from each item with kerosene or gasoline and finally wipe dry with a clean cloth.

It is essential that the Unit be placed upon a solid foundation. One of several methods may be used, depending upon the type and condition of the floor upon which the Unit is to be placed. Where the floor is of concrete, cork one inch thick, battleship linoleum or 1" x 8" skids of a medium wood, should be placed under the feet of the press. On wood floors only the 1" x 8" skids of a medium wood should be used.

Good practice is to place under the press, a sheet of tin, about 26 gauge by 36" wide, to act as an oil pan. This sheet should not extend beyond the actual floor dimensions of the press; in other words, it should be placed so that the operator never steps on the tin. Limiting the size prevents any chance of the operator slipping if oil has dripped onto the tin.

Two lag screws on the throw-off side are usually enough to keep the press from moving. Before tightening the screws be sure that the press is level, otherwise the excess strain on the base may pull it slightly out of alignment resulting in a stiff throw-off and tight bearings.

To level the press use a spirit level on the face of the small head and along the crank shaft just inside the flywheel. Then, if the throw-off is not free, check the level by the side arm method as follows:

Turn the flywheel so that the bed of the press stands in an upright or balanced position. Then remove one of the side arms. If it comes off and goes on easily, the press is level. If not, packing should be placed under the left front foot of the press. Then, if this does not cause the side arm to come off and go on easily, the operation should be continued to the other feet of the press until the place is determined where the packing is needed.

When motor equipment is furnished, a wiring diagram is included to assist the electrician. Particular attention must be given to the direction of the rotation of the motor pulley. This should be such that when facing the pulley of the motor the direction of rotation is clockwise.

The general practice is to place the control box as near the press as conditions permit and to fasten the start and stop button to the bracket provided on the left front of the press.

## CARE AND OILING

Always oil both press and feeder with a good grade of free-running machine oil before starting each day. We recommend the use of a No. 40 oil in Summer and No. 30 in Winter.

A successful method to follow when oiling is for the operator to commence at the same place each time and then continue around the machine until the starting point is reached. Oil holes should be used where provided but it is highly essential that every moving part be lubricated at a point of contact or bearing. Oil holes are painted red for easy identification.

Particular attention must be given to the main and back shaft bearings, the bed shaft, the pump and the crank shaft bearings; also to the feed and delivery operating arms, both on the slides proper and on their bearings at the bottom. Do not forget that all the bearings of the Unit are fitted to an exact tolerance; in order for press and feeder to function properly and without injury, frequent and thorough lubrication at all points is an absolute necessity.

### SPECIAL LUBRICATING INSTRUCTIONS

A good grade of ball bearing grease should be used in the form roller saddle ball bearings, and in the cam roller ball bearings of the feeder.

**Unpacking**

**Foundation**

**Leveling Press**

**Wiring**

**Lubrication**

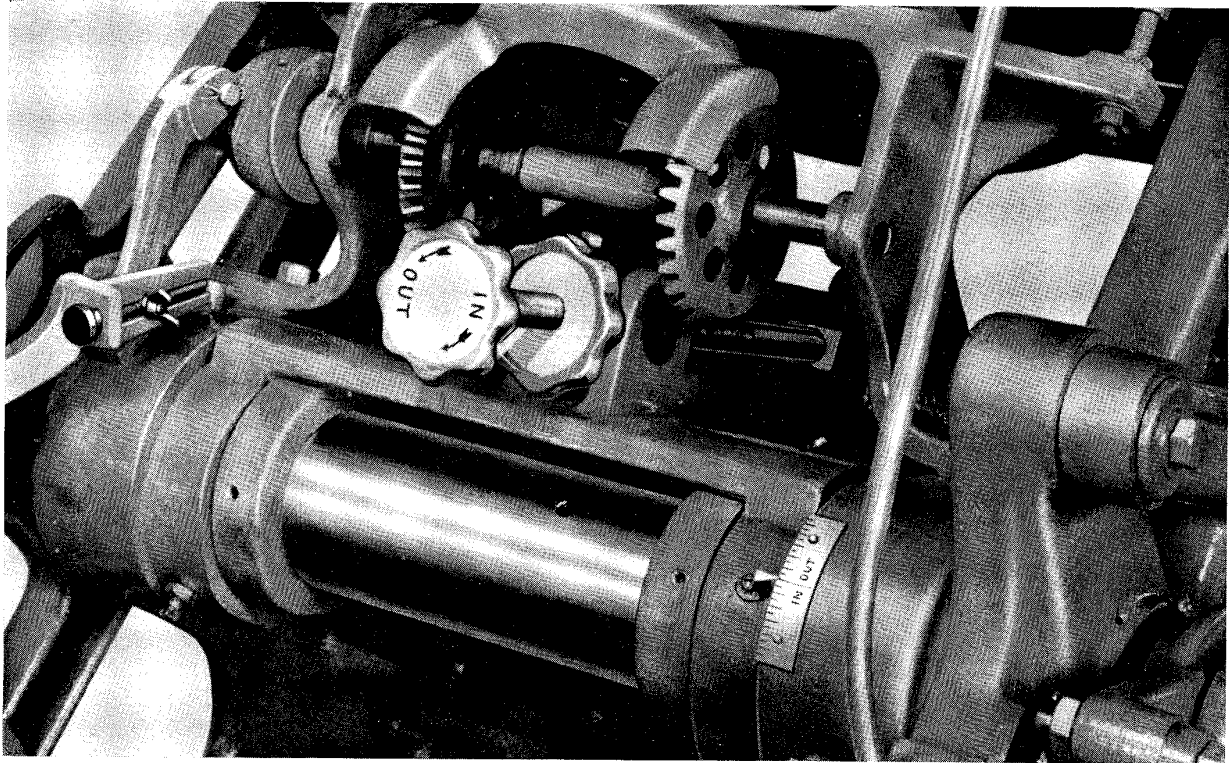

*Figure 3—Upper Hand Wheel controlling the impression*

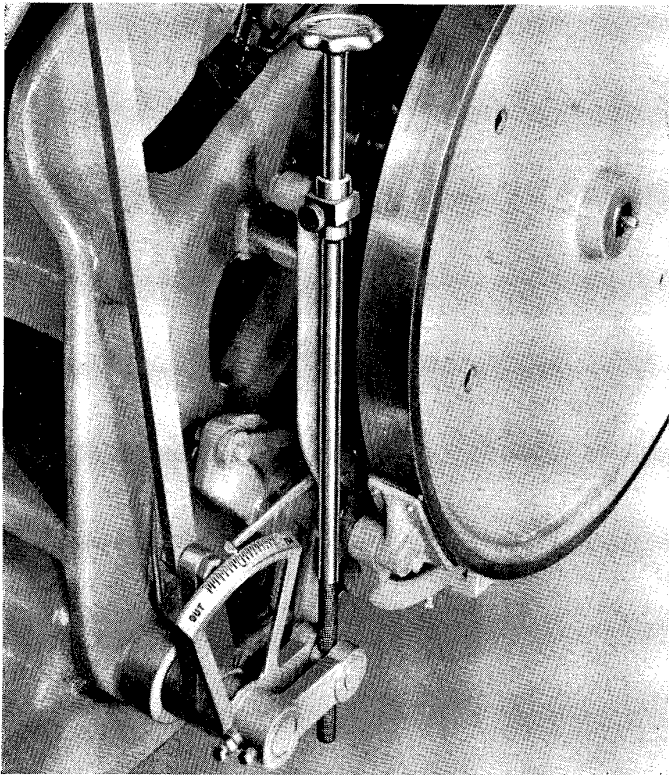

*Figure 4—Lower Hand Wheel controlling the impression*



Cup grease should be applied to springs which have rods on the inside such as the form roller long saddle springs and the fountain brayer arm spring.

Two or three drops of neatsfoot oil dropped into the feed and delivery valve chamber each week will be sucked into the pump by the pump suction and will keep the pump piston leather ring lubricated.

3-in-1 Oil or the equivalent should be used on the delivery cut-out and throw-off valve plungers.

One drop of oil a week in the disc drive clutch is sufficient. Too much oil in this mechanism will cause slippage.

**Screens for collecting paper lint and dust are inserted in the ends of the feed and delivery tubes.** They prevent foreign materials from being sucked into the pump and thereby upsetting the pump valve mechanism. These screens should be cleaned regularly. Simply take them out, clean with a dry brush or dip in gasoline if necessary. Before replacing be sure lint and dust are removed from end of tube.

Screens in the pipe unions at pump should be removed and cleaned periodically.

Pipe plugs in lower ends of feed and delivery slide castings must be taken out occasionally to remove collection of dirty oil, dust or lint.

The press should be turned over several times by hand to make sure that all connections have been properly made and that there are no interferences. It can be operated under power at slow speed and continually watched for bearings or moving parts getting warm.

The 10 x 15 Unit should not be run over 2700 and the 12 x 18 not over 2300 impressions per hour for the first few days. The maximum speed can be used after the Unit has had a fairly good run-in.

During the preliminary running and before the feeding operations start the feed and delivery arms and sucker heads should not be on the Unit.

## **Air Line Screens**

## **Preliminary Running**

# **SPECIAL FEATURES**

Platen impression screws on this press have been eliminated and replaced by hand wheels to control the position of the bed in relation to the platen so that the amount of impression can be regulated mechanically to the exact requirements of each individual job.

The hand wheel at the back of the press directly under the ink disc controls the movement of eccentric bushings placed over the back shaft and under the bed bearings. The other at the left of the press between the flywheel and bed regulates the movement of the bed shaft at the bottom on which the bed swings.

Indicators at the top and the bottom connected with the hand wheels and visible from the left side of press mark the position of the bed in relation to the platen. When both indicators point to the zero positions on the scales, the platen and bed are in correct relation for average size type forms consisting of approximately three six (6) inch lines of 10 or 12 point type (or the equivalent) on 100 lb. coated stock and when approximately .035" of packing (consisting of one draw sheet of oiled tympan, 5 sheets of 50 lb. S. & S. C. book paper and one manila pressboard of postcard thickness) is used on the platen. Heavier forms require more packing.

A movement of the upper adjustment toward "in" on the scale increases the impression at the top of the platen and to a lesser amount increases the impression at the bottom of the platen. Likewise a movement of the upper adjustment toward "out" on the scale decreases the impression at the top of platen and to a lesser amount decreases the impression at the bottom of the platen.

The above adjustments are used for increasing or decreasing the impression.

A movement of the lower adjustment toward "in" on the scale increases the impression at the bottom of the platen and decreases the impression at the top. Likewise a movement of the lower adjustment toward the "out" on the scale decreases the impression at the bottom of the platen and increases the impression at the top of the platen.

## **Hand Wheel Impression Control**

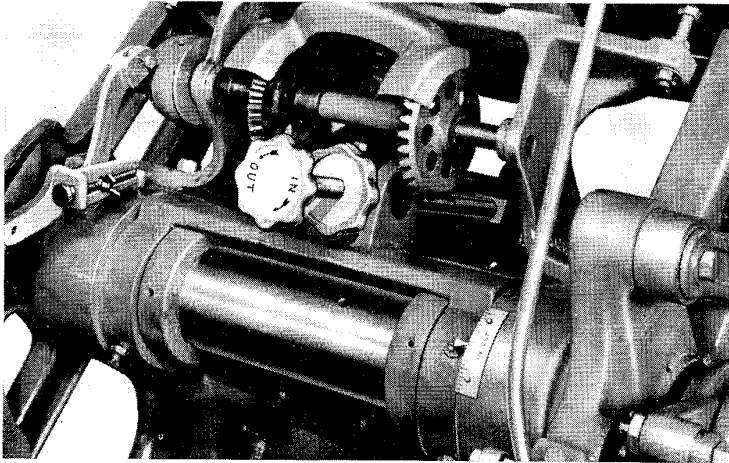

*Figure 5—Reversible Ink Disc*

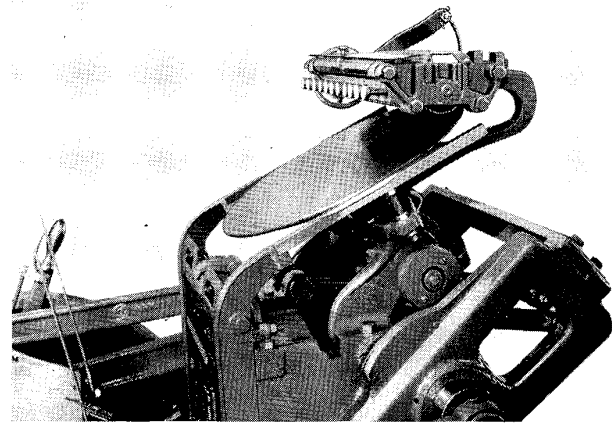

*Figure 6—Adjustable and replaceable bed tracks;  
also shows extension roller tracks  
on 10 x 15 Unit*

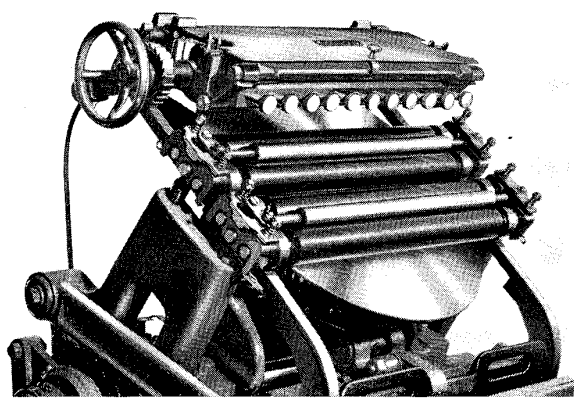

*Figure 7—Craftsman Long Fountain, standard  
equipment on 10 x 15 Unit*

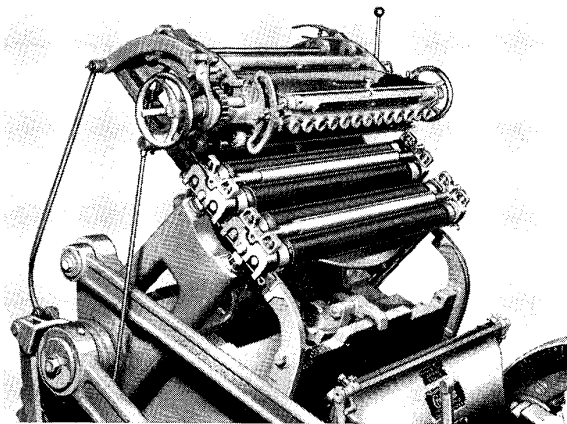

*Figure 8—Vibrating Brayer Fountain, standard  
equipment on 12 x 18 Units with  
Serial Numbers up to RD1648*

The above adjustments are used to compensate or even the impression.

To use the hand wheel impression controls properly, start the job with both indicators to the zero marks or toward the out positions because the best results are obtained by starting with a light impression and increasing as needed instead of starting with a heavy impression and decreasing. After pulling one impression, if more or less squeeze is required, adjust the upper hand wheel in or out for the correct amount of impression at the top of the platen. Then as this upper adjustment increases or decreases the impression at top of platen and to a lesser degree at the bottom of platen it may be necessary to adjust the lower hand wheel, as described above, to compensate or even the impression if the impression at the bottom of the platen needs to be increased or decreased.

A movement of one mark on the upper scale will not be the same as a movement of one mark on the lower scale. The pressman must move the upper or lower hand wheel independently an amount necessary for proper impression as determined by inspection of the printed sheet.

When the proper impression has been obtained, tighten the locking thumbscrew and nut at the hand wheels to prevent the setting from being moved by vibration. Then the makeready should be completed in the usual manner.

The adjustable and removable bed tracks are at either side of the bed; their purpose is to support the form rollers as they pass over the form. The tracks are set  $\frac{1}{8}$ " from the face of the bed when the Unit is shipped from the factory. They can easily be adjusted to take care of proper roller contact on form or can be replaced if occasion demands.

### **Adjustable and Removable Bed Tracks**

The extension roller tracks are at either side of the inking disc and are used to support the rollers when the rollers are on the disc. The tracks are set at the factory  $\frac{1}{16}$ " below the surface of the disc and parallel to the disc. They can be adjusted up or down for desired roller contact.

### **Extension Roller Tracks**

The direction of travel of the reversible disc can be changed by shifting the gears under the disc. Move the knurled spring lock collar a fraction of a turn on the shaft to unlock, then shift the vertical gears to mesh on the opposite side of the horizontal gear under the disc and allow the knurled spring collar to relock.

### **Reversible Ink Disc**

This feature is an advantage when it is desired to rotate the inking disc so that the fresh supply of ink from the fountain moves toward the side of the form where the solid to be printed is located; if the solid is locked at the right side of chase the disc should rotate clockwise; if at the left, disc should rotate counter-clockwise.

The Craftsman Long Fountain is standard equipment on the 10 x 15 Unit. The bracket for this fountain is not removed from the press for shipment. Therefore it is necessary only to place the fountain on the bracket, connect the driving rod, and place the retaining screws in the bracket forks.

### **Craftsman Long Fountain**

This fountain can be adjusted for proper form roller contact by means of the long thumbscrew located at the back of the fountain bracket. Lowering the fountain with this screw will increase the supply of ink going to the form rollers, while raising the fountain will decrease the amount.

The blade screws should always be adjusted by starting at the center screws and working toward the end to prevent ink leakage.

If the fountain is not being used, the roller should not be allowed to turn. In other words, the ratchet pawl should be thrown out of mesh with the ratchet wheel.

A partial wash-up can be made by backing out the screws in the ends of the blade holder so that the hinged blade holder assembly can be dropped. For a complete wash-up for color, disconnect the pin latch on the driving arm and remove the bearing caps so that the roll assembly can be taken out of the fountain.

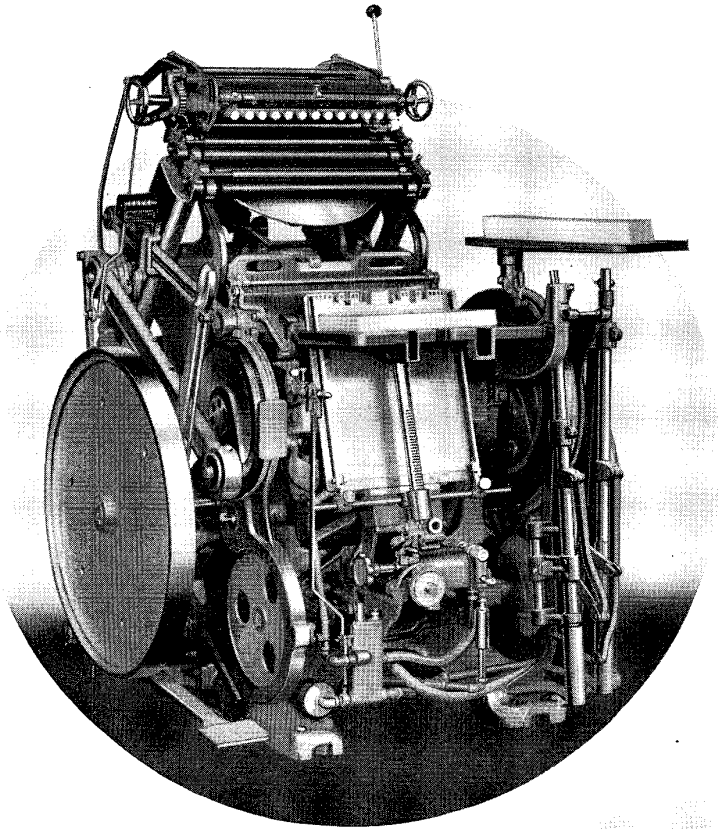

*Figure 9—The Craftsman Automatic Unit  
arranged for hand feeding*

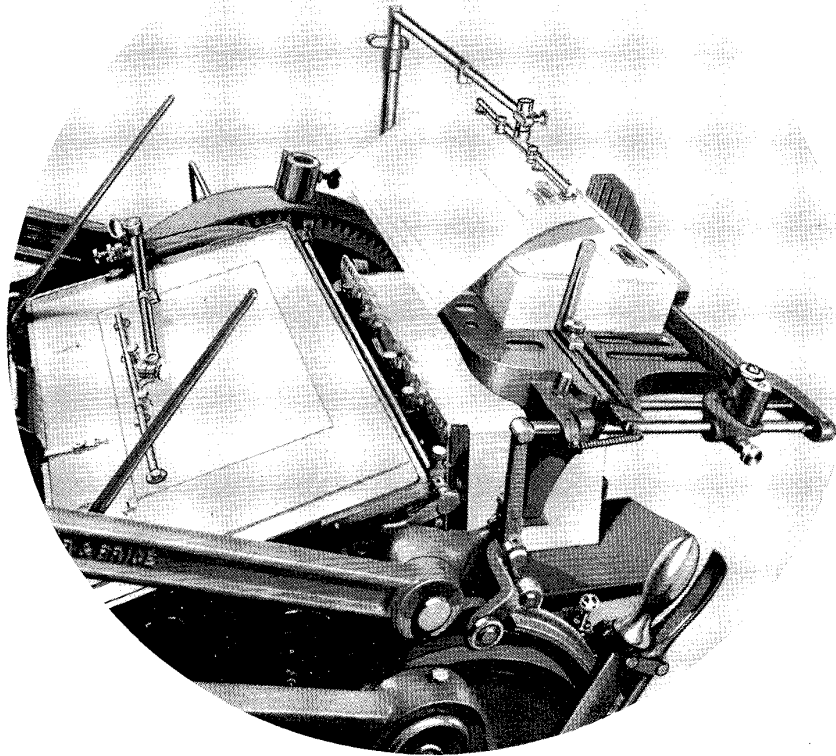

*Figure 10—Illustrating proper  
positioning of feed and delivery  
sucker tips on the sheets*

The Vibrating Brayer Fountain is standard equipment on the 12 x 18 Unit. The brackets for this fountain are not removed from the press for shipment. To attach this fountain, place fountain on bracket pads and insert screws. Adjust fountain on brackets so that the brayer roller lines up with the top form roller, then tighten the screws holding fountain on brackets. Next connect the fountain throw-off and driving rods. If brayer roller does not line up with fountain composition roller, adjust the eccentric provided at right upper end of composition roller arm.

The blade screws should always be adjusted by starting at the center screws and working toward the ends, to prevent ink leakage.

On this fountain the travel of the steel fountain roller can be regulated by positioning the slotted casting on the left end of fountain, which is held in position by the wing nut.

The vibrating brayer can be locked in an up position, to eliminate the transfer of ink from the fountain to the top form roller. Locking the brayer in the up position automatically moves the composition fountain roller away from the steel roller, thus preventing a "flat" on the composition fountain roller.

If, on any job, the fountain is not being used, the driving pawl should be raised up from the ratchet wheel to prevent the fountain roller from turning. This fountain is automatically thrown off each time the press throw-off operates.

A partial wash-up can be made by backing out the screws at the ends of the blade holder so that the hinged blade holder assembly can be dropped. A complete wash-up for color can be made by disconnecting the pins on the driving and throw-off rods and by removing the steel fountain roller caps so that the roll assembly can be taken out of the fountain.

To hand feed the Craftsman Automatic Unit, it is necessary to remove the feed arm and sucker head, remove the delivery arm and sucker head, remove the delivery table, DISCONNECT THE DELIVERY RAISING ARM and place the wooden feed table in its socket on top of the gear guard. Then turn the press over by hand to be sure there are no interferences.

The delivery raising arm is disconnected by removing the ball spring pin at the lower end of the raising arm where it connects the arm to the raising link. This should be done when the press is in the impression position. The pin should be replaced in the raising link during the hand feeding operation.

The automatic feed table, used as a delivery table during hand feeding, should be set at a convenient height to receive the printed sheets and adjusted all the way in toward the platen. To stop the table from raising automatically, the feeler adjustment screw should be moved out so it does not make contact with the feed table elevator trip trigger. The grip on the throw-off lever must be tied to the handle, otherwise the press will continue to throw off because the air line is open. Figure 9, page 12, shows the machine set up for hand feeding.

## **Vibrating Brayer Fountain.**

**12 x 18 Units Numbered RD 1649 and up are equipped with Micro-matic Ink Distributor. For instructions see folder tipped onto inside back cover.**

## **Hand Feeding**

# **OPERATION**

Sequence of operations for platen and feeder set-up:

1. Place packing and tympan sheet.
2. Take printed impression on tympan.
3. Set gauge pins and grippers.
4. Adjust impression and complete make-ready.
5. Set front position of feed table and feed table side guides.
6. Select and place register finger.
7. Select feed bar sucker tips.
8. Place feed sucker tips in position on sheet.
9. Set stripper wires.
10. Position register bracket.
11. Select delivery bar suckers.
12. Place delivery sucker tips in position on sheet.
13. Load feed table and adjust back stop.
14. Adjust pile height regulator.
15. Adjust blast and start feeding.
16. Adjust delivery table jogger.
17. Set ink controls.

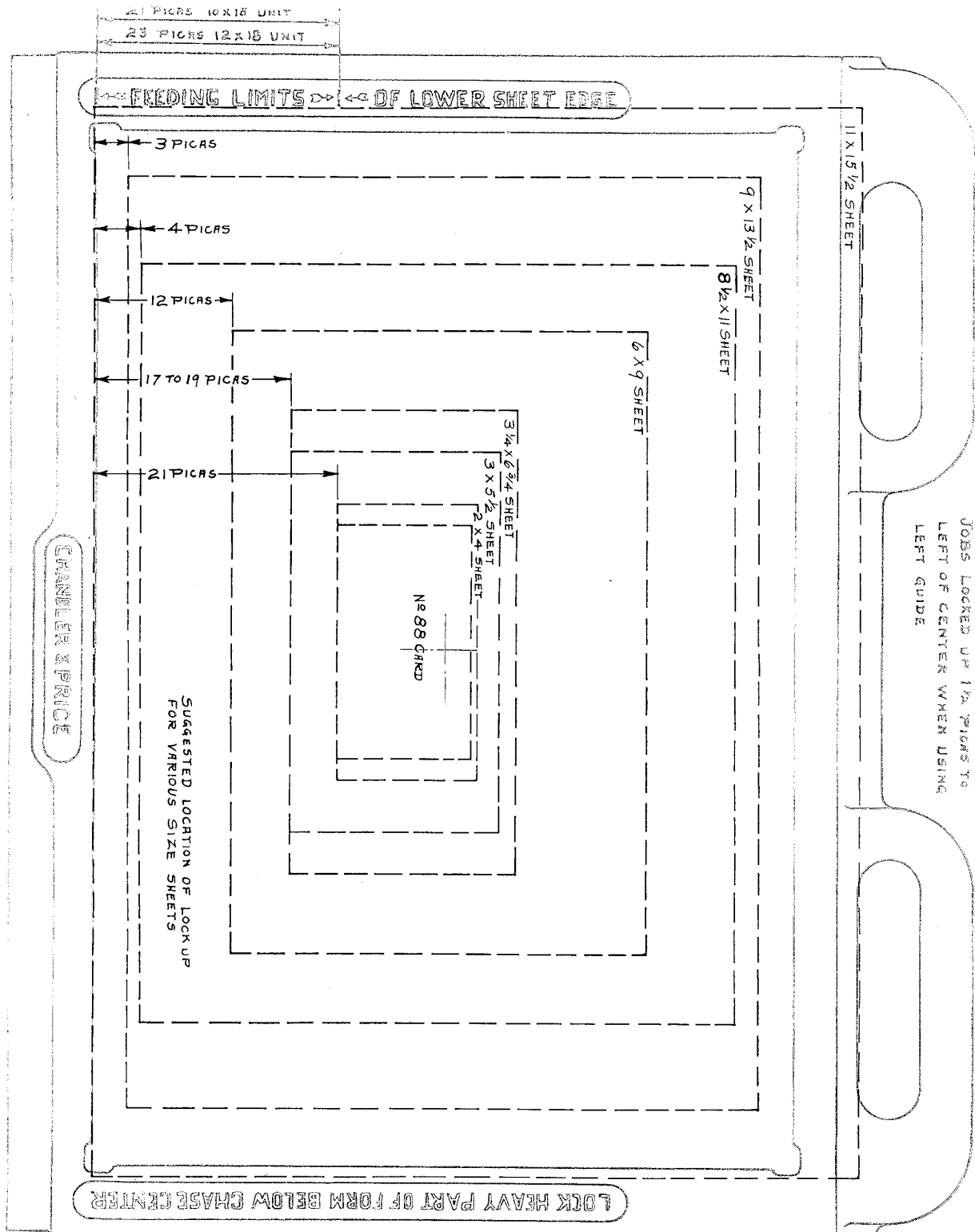

## DETAILS OF OPERATIONS

The amount of packing to be used for a three-line form is, as previously mentioned, approximately, .035", usually consisting of one draw sheet of oiled tympan, five sheets of 50 lb. S. & S. C. book paper and one manila pressboard of postcard thickness. For a heavy form more packing should be used.

The form should be locked in the chase so that, when impression is taken on the tympan, the lower edge of the sheet to be printed will be seen to come within the markings on the end of the chase; this is essential because these limiting marks correspond to the "In" and "Out" adjustment of the feed table and to the feeding limit of the feed arm.

The usual method should be followed to obtain the position of the form as locked in the chase in relation to the platen for the location of the gauges and the feeder setting. Chart No. 1 shows suggested locations of different sized sheets in relation to chase, which can be used by the lock-up man.

Three or four pins should be used, depending upon the size of the sheet. For example, on sizes up to approximately  $3\frac{1}{4}$ " by  $6\frac{3}{4}$ ", two lower and one side pin are sufficient, while on the larger sheets three lower and one side pin should be used. Approximate settings in relation to the sheet edges are shown in Chart No. 2.

The side gauge pin, on the average size sheet, should be placed from 1" to  $1\frac{1}{4}$ " from the bottom edge of the sheet. On small cards and envelopes this measurement should be reduced. The lower pin at the register end should be placed from  $\frac{3}{4}$ " on small sheets to about  $2\frac{1}{2}$ " on large sheets, from the register end of sheet. The lower pin opposite the register end of sheet should be placed about 1" to 3" in from the end of sheet.

On practically all jobs the grippers on this Unit can be set out from ends of printed sheet and the stripping done by rubber bands or strings stretched from gripper to gripper. If required, the grippers can be moved to any position along the lower edge of platen, or extension fingers supplied can be used.

Grippers should always be placed about  $1\frac{1}{2}$ " away from register bracket post, otherwise the lower end of register finger holder will interfere with gripper when register mechanism is functioning.

When a very small sheet is being printed, care must be taken in the placing of the right gripper to prevent interference with the delivery arm.

Adjust the impression control as previously suggested and follow up with the necessary spotting and patching required for good impression.

After the gauge pins are placed on the platen, a metal measuring bar is used to set the feed table accurately and quickly in relation to the position of the sheet on the platen. Assuming the platen is open and the gauge pins are set, the measuring bar is placed against a lower gauge pin and the feed table is then moved in or out by handle F, Fig. 14, until the face of the feed table front stop lines up with the inner side of the measuring bar projection. (See Fig. 13.) Then lock the table by means of the clamping screw (J, Fig. 14).

The same bar can be used to set the feed table side guides. Place this measuring bar on the platen about  $\frac{5}{16}$ " in from the side gauge pin and parallel to the right or left end of the platen; then set the feed table side guide to the measuring bar. This  $\frac{5}{16}$ " is the amount required for registering the sheet to the side gauge pin after sheet is fed onto platen.

Before placing register finger on bracket be sure register operating spool is at the low part of operating cam, then select a register finger long enough to extend about  $\frac{1}{2}$ " over the edge of the sheet in the position as it is fed onto the platen or so that the bottom edge of the sheet is just beyond the convex section of the register finger spring. The tension of the finger spring should be adjusted so as to be just strong enough to pull the sheet to the

### 1. Packing and Tympan Sheet

### 2. Printed Impression on Tympan

### 3. Gauge Pins and Grippers

### 4. Impression Adjustment and Make-Ready

### 5. Front Position of Feed Table and Feed Table Side Guides

### 6. Register Finger

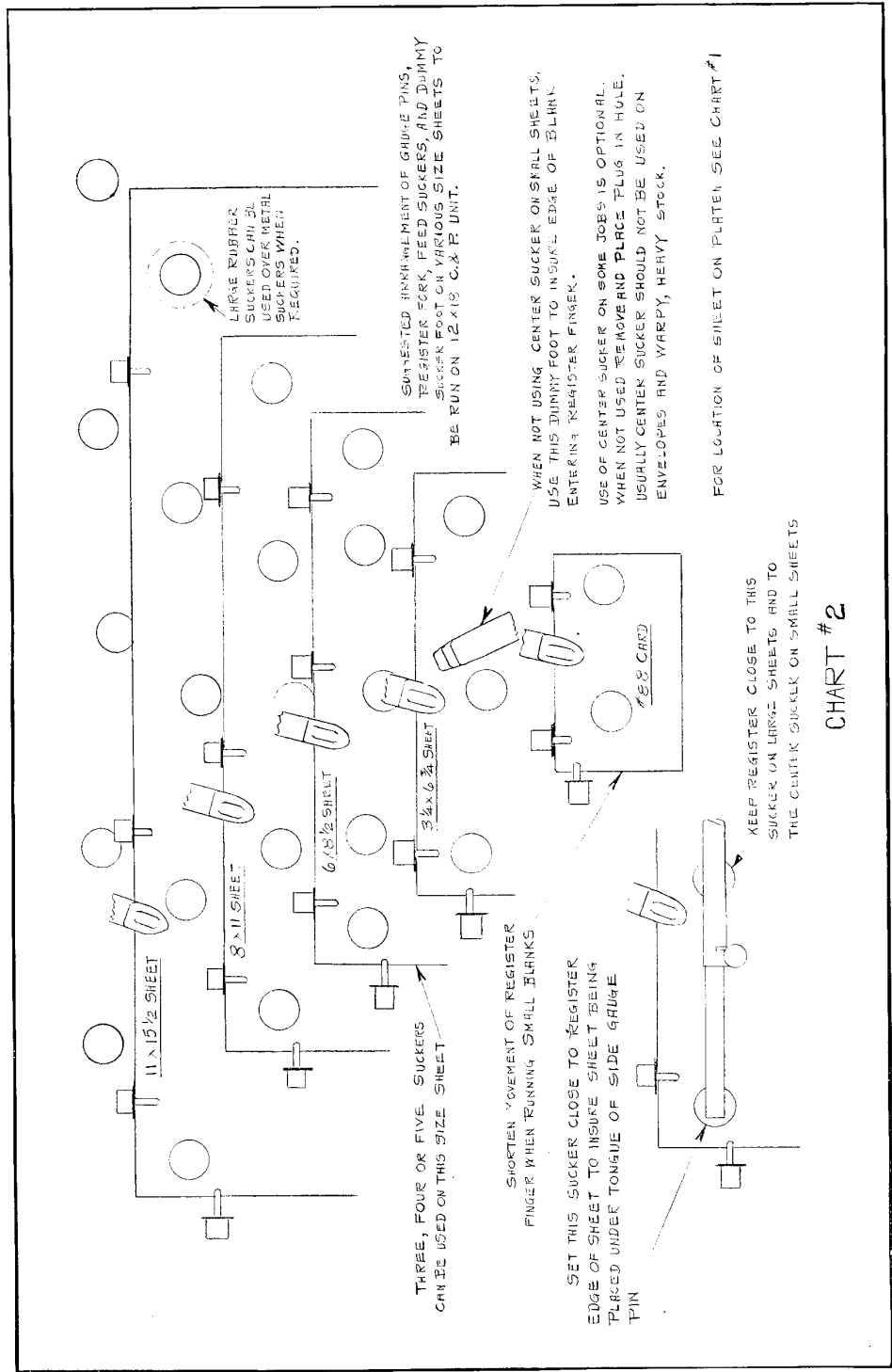

LARGE RUBBER SUCKERS CAN BE USED OVER METAL SUCKERS WHEN REQUIRED.

SUGGESTED ARRANGEMENT OF GUAGE PINS, REGISTER FORK, FEED SUCKERS, AND DUMMY SUCKER FOOT ON VARIOUS SIZE SHEETS TO BE RUN ON 12 x 18 C&P UNIT.

THREE, FOUR OR FIVE SUCKERS CAN BE USED ON THIS SIZE SHEET

SHORTEN MOVEMENT OF REGISTER FINGER WHEN RUNNING SMALL BLANKS

SET THIS SUCKER CLOSE TO REGISTER EDGE OF SHEET TO INSURE SHEET BEING PLACED UNDER TONGUE OF SIDE GAUGE PIN

WHEN NOT USING CENTER SUCKER ON SMALL SHEETS, USE THIS DUMMY FOOT TO INSURE EDGE OF BLANK ENTERING REGISTER FINGER.

USE OF CENTER SUCKER ON SOME JOBS IS OPTIONAL. WHEN NOT USED REMOVE AND PLACE PLUS IN HOLE. USUALLY CENTER SUCKER SHOULD NOT BE USED ON ENVELOPES AND WARPY, HEAVY STOCK.

FOR LOCATION OF SHEET ON PLATEN SEE CHART #1

KEEP REGISTER CLOSE TO THIS SUCKER ON LARGE SHEETS AND TO THE CENTER SUCKER ON SMALL SHEETS

CHART #2



gauges without buckling. To check the tension, place a blank sheet to be printed in the register finger against the bottom gauge pins and about  $\frac{5}{16}$ " away from the side gauge pin and move the register finger by turning manually the register operating arm at the left of the platen, noting the results with respect to the movement of the blank. The mechanism should cause just enough friction to move the sheet against the side gauge but at the same time allow itself to become free when the blank comes into contact with the side gauge.

Another method that can be used to check the tension of the register finger spring is to place a sheet of paper in the finger before the finger is placed on the press. When properly set, the tension should be just enough to lift the sheet, no more.

If too much tension is exerted by the spring, it will buckle the sheet slightly and cause a rebound when sheet is released by the register finger. If not enough tension is exerted by the spring, it will move the blank only slightly or possibly not at all.

It may be found necessary on particular kinds of stock to alter the register finger spring slightly to obtain the proper tension. Fig. 12 shows the assembly of a register finger and spring. It will be noted that the spring is curved up at point 1, at 2 a portion of it comes close to the finger, at 3 it is bent up to clear the finger, and at 4 it is bent down so that the remainder lies flat on the finger, being held down by the small knurled nut 6 which must always be turned down tight. This is the normal shape of the spring with respect to the finger.

To alter the tension of the spring, bend slightly at point 4. When changing the tension, be sure not to distort or change the shape of the register finger spring at points 1, 2 and 3. Always keep the grooved part of the spring central with the narrow part of the tongue of the register finger at point 5, Fig. 12.

The angle of a register finger should be approximately 15 degrees in the registering direction from a line up and down through the center of platen as shown on Fig. 11.

The movement of the finger can be regulated by adjusting the travel of the spool on the end of the platen rocker.

The self-contained telescopic construction of the feed head permits the use of 1, 2, 3, 4 or 5 sucker tips at any one time on the 10 x 15 Unit, and 1, 2, 3, 4, 5 or 6 on the 12 x 18 Unit. Metal sucker tips should be used on the feed bar when feeding any stock from onion skin to light cover stock. Rubber sucker tips should be used on the feed bar when feeding heavier paper, cardboard or envelopes. When rubber tips are required on the feed bar, always use the large rubber tips.

The rubber sucker tip is placed on the feed bar by stretching it over the top of the metal sucker tip.

When placing sucker tip holders in the sucker head, be sure the clamping screws come on the same side of the sucker head as the screws on the head are located, otherwise screws will interfere with feed table side guides.

The plugs provided should be placed in the center and end openings of sucker head and in the ends of the sucker tip holders when all of the suckers are not being used.

First, place the suckers as selected above in the sucker head and level the faces. Next turn the press until the feed arm curved tube comes to the lowest position in relation to the feed table. Then place the feed arm on the curved feed tube with all clamping screws loose for adjusting purposes. Grasp the feed arm head with the left hand and with the right support the telescopic section of the arm. Adjust to bring the suckers parallel with the feed table front stop and about  $\frac{1}{2}$ " away. This distance varies depending upon the stock that is being fed—as for example, on the thinner stocks the distance can be reduced to  $\frac{3}{8}$ ", while on the heavier card stock the distance can be increased to  $\frac{5}{8}$ ". Next slide the feed arm in or out until the sucker tip on the register end is about  $\frac{1}{4}$ " to  $\frac{5}{16}$ " away from the end of the sheet and the opposite end sucker 1", 2", or 3" away from the other end of the sheet. Securely tighten all the clamping screws and adjust and lock the limiting screw on the end of the curved feeding tube.

## 7. Feed Bar Sucker Tips

## 8. Feed Arm

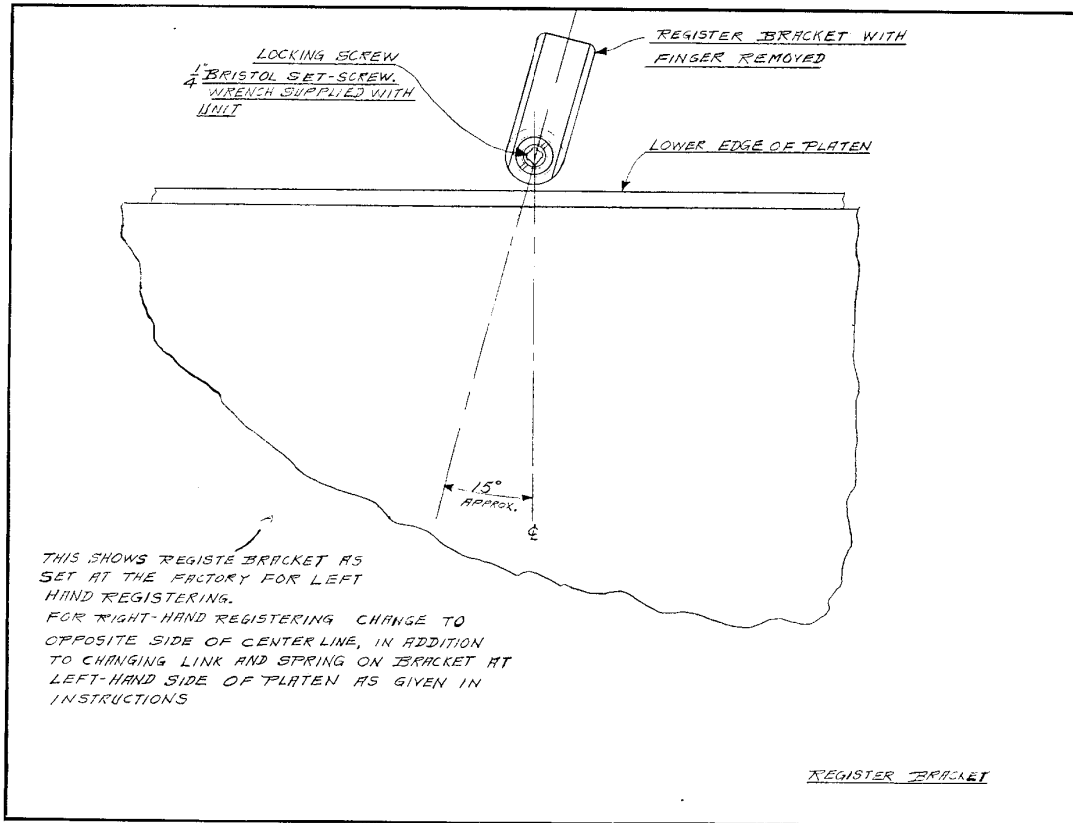

Figure 11

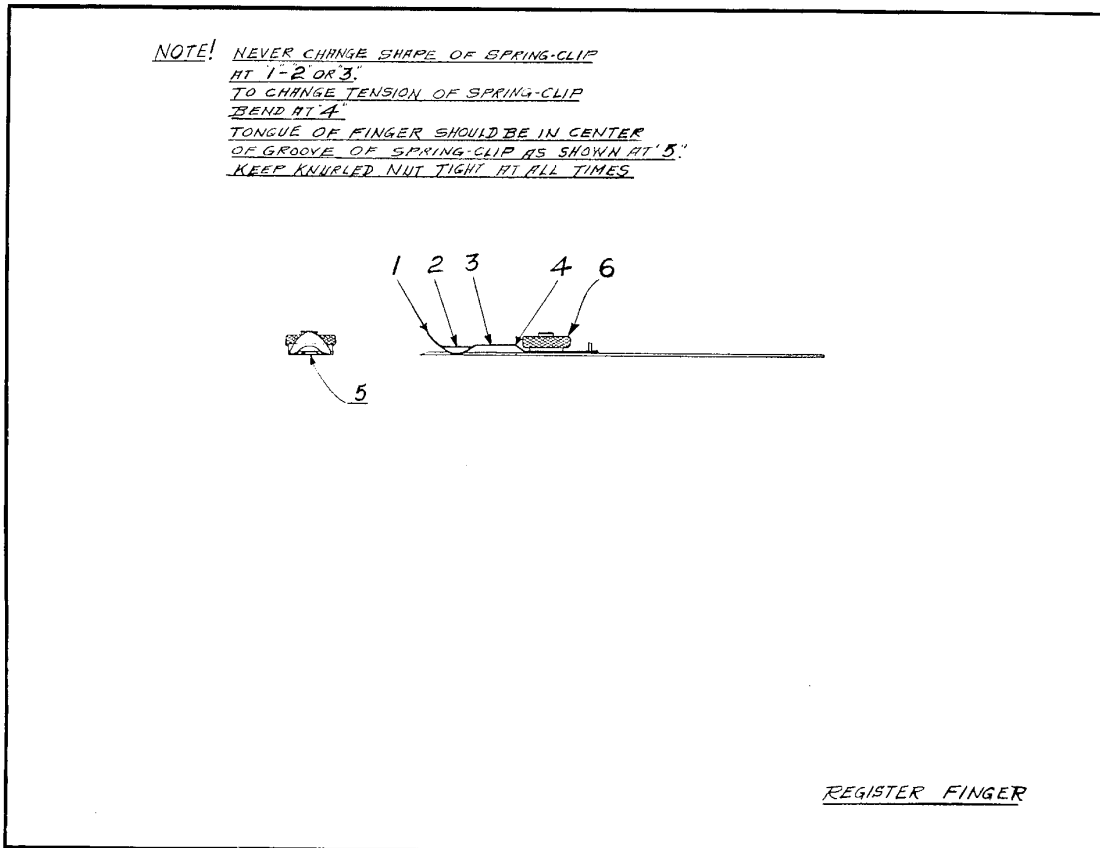

Figure 12

When the feed bar is in the platen position, the faces of the suckers should be parallel to the face of the platen.

Dummy sucker feet are furnished, and one should always be placed near the register fork when using only two sucker tips, as it will always assure that the sheet being fed will properly enter the register fork.

Chart No. 2 shows the general arrangement of the feed bar sucker tips in relation to different sized sheets.

One stripper wire should be placed directly in front or slightly to one side of each sucker tip, if possible. If a location can not be selected as above, it is best not to use a wire for the reason that the wire, if placed between two suckers, will cause a buckle in the sheet and have a tendency to pull the sheet away from the suckers. The wires should never be placed lower than  $\frac{1}{16}$ " above the lowest position of the feed bar suckers when over the feed table.

The ends of the wires should extend over the edge of the stock from  $\frac{1}{8}$ " to  $\frac{1}{4}$ ", depending upon the weight of the stock. On light stocks, which are flexible and have a tendency to yield to the lift of the suckers, use the longer extension; on heavier, unyielding stocks, use the shorter extension.

The register bracket is adjustably mounted along the lower edge of the platen under the gripper bar. It can be moved along the lower edge of the platen to any position by unlocking the spring clamp screw. To position correctly along the lower edge of the platen, first turn the press until feed arm is at the lowest position on the platen. Then adjust the bracket along the bottom of the platen to a point very close to either side of the second sucker tip from the register end when more than two suckers are used, or to a point as near the register end as the gauge pin will allow when only two suckers are used.

After the register bracket and finger are placed properly in relation to the sheet, it is a good practice to cut a Vee in the platen draw sheet to allow the extreme end of the steel finger to go under the draw sheet when it is in position of receiving the sheet. This Vee eliminates the possibility of the sheet going under the finger or of the edge of the sheet hitting the end of the steel register finger thereby disturbing the register.

As previously mentioned, a dummy sucker foot should be used on the feed bar to insure entrance of the edge of the sheet entering the register fork when using two suckers only. A general layout or register positioning in relation to the gauge pins and suckers is shown on Chart 2.

As sent out from the factory, the register mechanism is set to register to the left. To change to the right-hand register, simply disconnect the driving link and spring from the bottom pin of the operating arm located at the left of the platen and connect the link and spring to the top of the arm on the pin provided.

As mentioned before, the finger holder when registering to the left should be set at an angle approximately 15 degrees to the left of a line up and down through the center of the platen; when registering to the right the 15 degrees should be to the right of the same center line. When necessary the angle noted above can be changed by unlocking the bristol set screw in the register finger holder as shown on Fig. 11.

The self-contained telescopic construction of the delivery head permits the use of one, two, three or four sucker tips at any one time. General rules to follow are:

When cards or envelopes are being printed, use the one projecting center sucker tip. When sheets up to about 8" in length are being printed, use two sucker tips. When sheets from 8" to 11" in length are being printed, use three sucker tips. When sheets more than 11" in length are being printed, use four sucker tips.

If the job requires three sucker tips, always use two sucker tips at the left end so that the delivery bar does not have to be pulled out to the extreme position.

For most jobs the large rubber sucker tips can be used. Small rubber sucker tips are also furnished to be used on paper only (never on card stock) but these should only be used when it is impossible to use the larger sucker tips. In unusual cases, where the stock

## 9. Stripper Wires

## 10. Register Bracket

## 11. Delivery Bar Sucker Tips

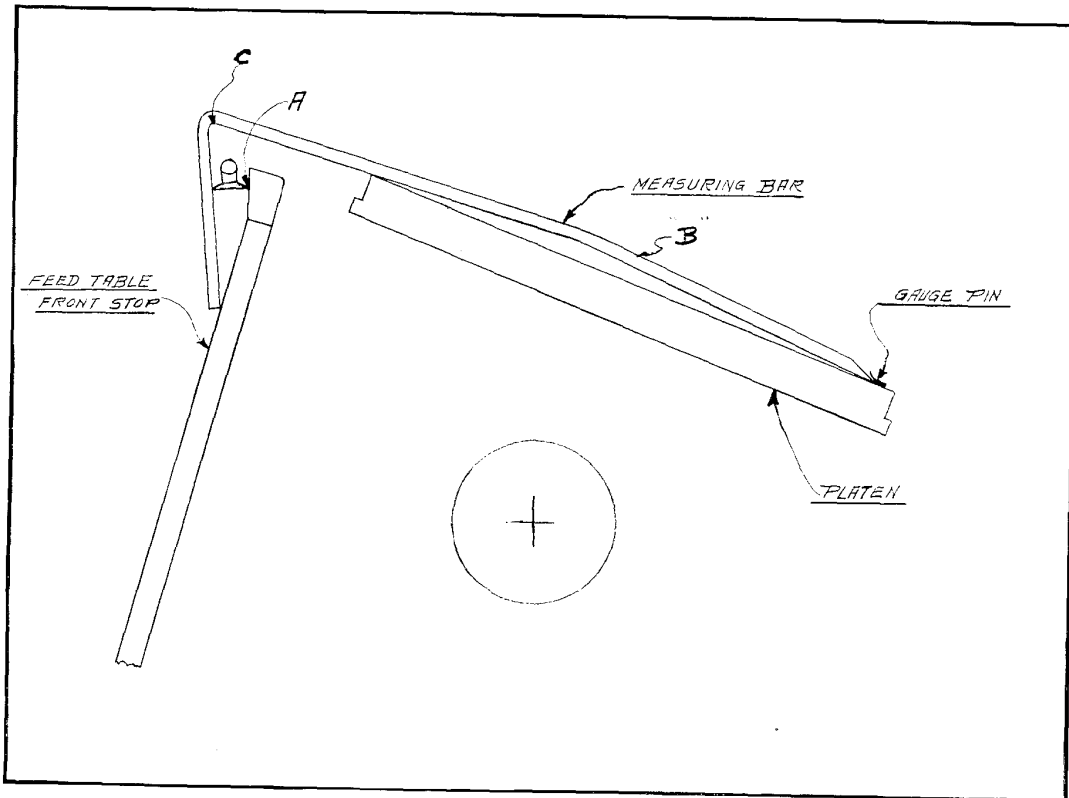

Figure 13— Illustrating proper use of Measuring Bar to position stock pile in relation to platen

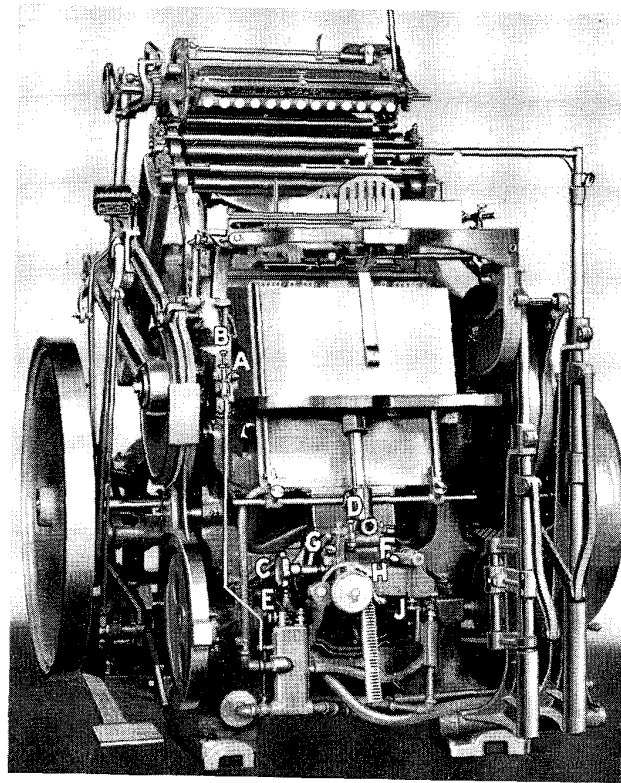

Figure 14— Illustrating feeding controls and adjustments

is so light that it has a tendency to suck up into the rubber tip, it is necessary to use the metal tip. To change from rubber to metal tips on the delivery bar, simply unscrew the tip itself from the head, turn it upside down and rescrew it into the head, bringing the metal tip into the "down" position.

When it is found necessary to come down with the delivery sucker tips onto wet ink on the sheet, the emery discs provided should be attached with rubber cement to the faces of the large metal and rubber sucker tips to prevent smearing the wet ink.

Place the delivery arm, with the delivery head assembled, onto the end of the delivery tube and turn the press until the delivery sucker tips come down onto the platen. Adjust the delivery sucker tips along the sheet to be delivered, being sure that the suckers are placed as near the upper edge of the sheet as possible and are tilted so that the forward edges of the sucker tip faces are nearest to the platen. Securely clamp the wing nut to hold the delivery arm in position, then set and lock the limiting screw at the end of the delivery tube and check to see that all delivery bar and head screws are tight. Also turn the press over by hand to be sure the delivery mechanism does not interfere with right gripper.

Lower the feed table to the lowest position. To do this, disengage the clutch G, Fig. 14, with the right hand and with the left hand create a braking action on the raising and lowering hand wheel C, Fig. 14, to prevent a sudden drop of the delivery table.

The tape with weight on the bottom of the delivery table is for backing up the stock on the feed table. To adjust, place the tape in against the stock so as to hold the stock against the feed table front stop. Keep in mind that the stock should never be cramped in between the front and back stop but instead the weighted tape should exert a slight push against the stock. The casting holding the tape can be turned forward or backward to contact the different sized sheets. The long envelope finger can be used when envelopes or small jobs, requiring more accurate control in the feed table, are being fed.

To raise the feed table manually, simply grasp the table by the back and left edge and lift it through the ratchet. If only a small amount of movement is desired, turn the hand wheel C, Fig. 14, in a clockwise direction. Sometimes to feed the last few sheets on the table it is necessary to raise the table slightly by turning the hand wheel manually.

The sheet separating principle on the Unit is that the feed sucker tips never come down to contact the top of the pile of stock on the feed table; instead, the top sheet of the pile is blown up to the feed bar sucker tips. Thus it is necessary to adjust the pile height regulator so that, with the blast off, the feed table raising mechanism stops operating when the top sheet on the feed pile comes to rest approximately  $\frac{1}{4}$ " below the lowest position of the feed sucker tips. When feeding card stock this dimension should be reduced.

To make this correct setting, start the motor, turn off the blast and adjust the thumb-screw D, Fig. 14, to the position which allows the top of the stock pile to move up and stop about  $\frac{1}{4}$ " below the lowest position of the feed sucker tips when paper is being fed, or a slightly less distance when cardboard is being fed.

To make the feed table raise higher, turn screw D in; to keep table lower, back the screw out.

The ratchet triggers H, Fig. 14, are used to control the amount the feed table raises at each cycle of the press. With both triggers against the ratchet wheel, the table lifting mechanism, when it functions, will raise approximately  $\frac{1}{32}$ "; with only the back trigger against the wheel the table will raise approximately  $\frac{1}{16}$ ". If the stock being fed is less than  $\frac{1}{32}$ " in thickness, use both triggers; for stock more than  $\frac{1}{32}$ " thick, use only the back trigger. Note that the back trigger should always be in contact with the ratchet wheel.

The blast for sheet separation is directed against the forward edge of the stock on the feed table through the four nipples located back of the feed table front stop. The direction of the blast can be altered by turning each nipple as a unit, or it can be adjusted vertically by turning the knurled collar on each nipple. The amount of the blast from the pump

## 12. Delivery Bar

## 13. Loading the Feed Table

## 14. Pile Height Regulator

## 15. Blast Adjustment

can be regulated by adjusting the screw B, Fig. 14. Turning down screw B decreases the blast at the front of the stock pile, while backing out screw B increases the amount of blast. In other words, turning down screw B allows part of the blast from the pump to escape through the muffler at the bottom of the valve assembly.

To adjust the blast start the press under power. Drop the control handle A, Fig. 14, and adjust the blast screw B, Fig. 14, so that the top sheet on the feed pile is fluffed up to the feed sucker tips.

The blast ordinarily operates intermittently, functioning just before the sheet is picked up by the sucker tips and then stops after the sucker tips lift the sheet from the table. On some stocks, particularly heavy stocks, a continuous blast is occasionally required. To obtain this continuous blast, back out screw E, Fig. 14, so that the inner end of the screw is away from the blast valve cam lever.

The blast adjustment is very important because on this feeder, as mentioned before, perfect separation is obtained by blowing the sheet up to the sucker tips.

## 16. Delivery Table Jogger

The front and right hand joggles on this machine are stationary while the back and left hand are moving joggles. To set the joggles, place the front and right joggles in the position the stock is being placed on the delivery table, then adjust the moving joggles to proper position for accurately piling the printed sheets.

The joggling mechanism can be disconnected by simply turning the lever away from the end of the jogger operating rod.

The delivery table can be unloaded at any time by simply swinging the back jogger on its pivoting bracket.

## REGULAR ATTACHMENTS AND THEIR USES

### Saddle Lifter

A saddle lifter is supplied with each unit for use in raising the saddles when it is necessary to remove the form rollers. To remove the upper rollers, place the hole in the end of the lifter over the lower saddle pin extension at the right and the part adjacent to the handle of the lifter under the upper saddle pin extension. Then raise up on the lifter. To remove the lower rollers do the same as above except place the part adjacent to the handle of the lifter on top of the upper saddle pin extension and push down on the lifter.

### Tympan Bale Lifter

A tympan bale lifter is also supplied with each unit for use in raising the tympan bale up from the platen. To use the tool, place the hook under the bale on the lower side and the neck on the surface of the platen. Use as a pry to raise the bale.

### Extension Grippers

All grippers are grooved in the center for holding extension fingers. The extension fingers are provided in three lengths, 1", 2" and 3". The extensions are used to help strip the sheet from the form after printing. Care must be exercised in their use and adjustment to be sure the sheet is not moved out of register position by their contact with the sheet.

### Vibrators

Two vibrators are standard equipment on the Unit. A vibrator should be placed on top of each pair of form rollers to break up the ink thoroughly whenever exceptional distribution is desired. To place vibrators in position, turn over the press until the form rollers are on the curved part of the bed tracks just above the form, then while standing at the right side of press, place the threaded end of the vibrator in the hole in the bracket on top of the form roller saddle. Next compress the sliding clamp spring on the right end of the vibrator and insert right end of vibrator into the bracket on top of the right form roller saddle. Be sure the sliding clamp fits under and into the groove of the roller saddle. Adjust the vibrator up or down until the contact between vibrator and form roller is approximately  $\frac{1}{16}$ " to  $\frac{1}{8}$ " wide.

An adjusting slip clutch is provided on the right end of vibrator to insure vibrator turning as the rollers move up and down, and to slip when the vibrator moves to one side before the full travel of the form rollers is completed.

When the trip trucks are used on the lower form rollers, the vibrator used on these

rollers will always run toward one end, because these form rollers turn on different truck diameters on the way up and down over the form.

Trip trucks are special roller trucks for use on the two lower form rollers when exceptional ink distribution is required. They raise the two lower form rollers from the form on the way down and drop the rollers to the form height on the way up. They are generally required when more than 9 square inches of solid is being printed.

The hold down device fitted to the upper edge of the platen is to be used when the sheet printed has a tendency to roll or curl, thereby getting out of position for delivery. Wires furnished with the unit should be placed under the grooved washers at the top of the brackets on the square shaft, with the ends extended at angles of approximately 45 degrees to the corners of the printed sheet. The brackets should be positioned toward the ends of the platen to prevent an interference with the feed bar as it returns from the platen and so that the wires are lifted out of line of the delivery bar when it comes down to the platen to deliver the sheet.

When not in use it is necessary to keep the hold down wire brackets at the outer ends of the square bar and clamped to the bar in these positions.

The feed bar sheet control finger is a flat brass strip  $\frac{1}{2}$ " wide by 6" long (furnished with the 12 x 18 Unit only) and is to be used to prevent the upper edge of certain stocks in the larger sizes from rolling down the platen as they are fed. To use the finger, attach the end with the hole under one of the thumbscrews of the feed head and position finger so that the opposite end extends back or in contact with the tail of the sheet to prevent it from rolling or catching up to the front edge as it is being placed by the feed arm against the bottom guides.

Figure 15 shows the feed table set up for single envelope feeding. The long finger supporting the stack at the back is furnished with each Unit together with the lower supporting post and bracket. The finger should be positioned so as to contact the envelopes very lightly at the back and the brass clip at the top should just contact the top envelope to prevent the usual spongy condition from raising the pile too high.

## Trip Trucks

## Hold Down Device

## Feed Bar Sheet Control Finger

## Envelope Finger

## Envelope Feeding

## Small Sheets and Cards

- (a) Lock the form in chase so that the lower edge of the envelope comes from 18 to 23 picas above the lower inside edge of the chase.
- (b) The end sucker on the feed bar must always be approximately  $\frac{1}{4}$ " from the register end of the envelope, to insure register.
- (c) When two suckers are used, the dummy sucker foot must be placed as near as possible to the forward edge of the envelope, and close to the register fork.
- (d) The feed table elevator should be set to keep the top of the pile in the lowest possible feeding position.
- (e) The stripper wires must be set higher than when feeding regular stock.
- (f) Judgment must be exercised in the amount of blast to be used. Sometimes the blast can be shut off entirely.
- (g) Envelopes can be fed with the flaps in any position. If the flaps are fed underneath and forward it is necessary to attach to the front delivery table jogger a piece of one-point brass rule at the proper angle to guide the flaps over the top of jogger. If envelopes are reversed, so that flaps come underneath toward upper edge of platen, a similar device must be fastened to upper edge of platen underneath the platen bale, to prevent flaps from catching on upper edge of platen as envelopes are fed. General practice is to feed envelopes with flaps underneath and forward.

The envelope finger supporting post and bracket with the two long supporting rods should be used to back up small size sheets or cards which have a tendency to get out of line when stacked on the feed table. Feed table side guides, when feeding a No. 88 card only, should be changed to opposite side of their supporting brackets. When feeding the very small cards it is good practice to use only one sucker tip on the feed bar and to remove the two lower form rollers.

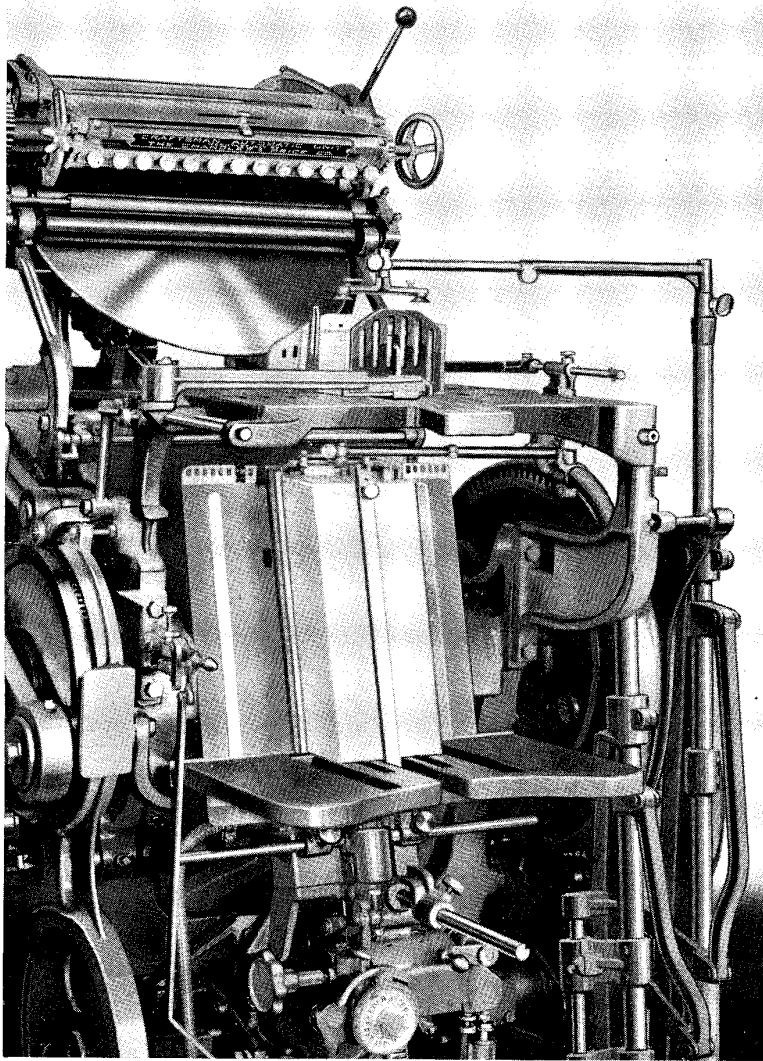

*Figure 15— Unit arranged for feeding made-up envelopes*

## **SPECIAL ATTACHMENTS AND THEIR USES**

### **Two-Up Feeding Attachment**

Figure 16 shows the Unit equipped with the two-up feeding attachment. This device will handle at one time, two sheets of the same thickness, within the size limits of the feeder and chase. The two sheets do not have to be the same size, but they must together measure less than the largest sheet the feeder will handle by an amount sufficient to allow room for the center feed table guides and the platen end gauge pin.

Settings for two-up feeding should be made exactly the same as for single feeding previously explained.

When not being used for two-up feeding, the second register bracket should be moved to the extreme end of the register bar out of the way, so as not to interfere with single feeding.



An electric or gas heater or spray gun are available for use with the Unit. (See Fig. 17.)

The electric heater fits above and over the top of the delivery table on a post and bracket provided with the heater, and swings out of the way with the delivery table when the delivery table is opened up.

The gas heater clamps to the front of the delivery table so that the sheet is delivered through the flame. It also swings out of the way with the delivery table and is equipped with an automatic electric cut-out.

The spray gun method of drying is well adapted to this unit because the sheets are delivered at the top where the mix can be directly applied. Links, etc., are attached to the leg of the bed to shut off the spray automatically when the press is in the off-impression position.

For die cutting work a hardened steel plate, standard thickness .050", can be supplied to fasten by means of screws to the face of the platen.

Figure 18 shows the Unit equipped with a continuous delivery table. This device fits on top of the regular delivery table; by means of endless tapes, it moves the printed pieces away from the platen at a speed of approximately  $\frac{1}{2}$ " to each cycle of the press. The continuous delivery table is particularly well adapted to the handling of envelopes in large quantities, also to thick folders or heavy boards which have a tendency to fill up the regular delivery table quickly.

The mechanism is fastened readily to the slotted side jogger bars and is operated by ratchet and pawl with power supplied by the moving jogger operating shaft. When continuous delivery table is used, the stop collar provided should always be in place to prevent interference with the delivery arm when the delivery table assembly is swung out of operating position.

Fig. 19 shows the Unit with special arrangement for feeding envelopes before they are folded. With this device, the died-out blanks can be fed with the flap extension to the platen guides. The feed table top is made up of a series of flat steel strips which can be moved to different positions in order to control the blanks properly.

This table can also be used to support regular jobs in the usual way.

The folder delivery sucker head is provided for delivering folders or booklets which have a tendency to open up as they are raised from the platen. It consists of a suction trigger which is sucked under the folder, thereby keeping folder or booklet closed. This head replaces the regular delivery head and is made with either one or two suction triggers to take care of either small or large folded pieces.

Standard machines, as previously explained, are geared to raise the feed table  $\frac{1}{32}$ " or  $\frac{1}{16}$ " at each cycle of the press. If a greater lift than this is required, the regular double threaded worm and gear can be replaced by a quadruple threaded worm and gear which will raise the table  $\frac{1}{16}$ " or  $\frac{1}{8}$ ". The use of the quadruple gear does not prevent the feeding of thinner stocks.

For feeding pieces which are thicker at one end, such as tags in multiple, paper bags, etc., a false top for the feed table is provided to compensate for this extra thickness and to keep the top of the stack in proper feeding position. The front type of tilting table is used when the thick ends of the envelopes, tags, etc., are to be fed to the lower platen guides.

This device is similar to the device described in the preceding paragraph, except that it is designed to be used when the thick ends of tags, envelopes, etc., are to be fed to platen side guide.

## **Ink Drying Attachments**

## **Cutting Plate**

## **Continuous Delivery Table**

## **Died-Out Envelope Feed Table**

## **Folder Delivery Sucker Head (Single and Double)**

## **Feed Table Worm and Gear (Quadruple)**

## **Tilting Table (Front Type)**

## **Tilting Table (Side Type)**

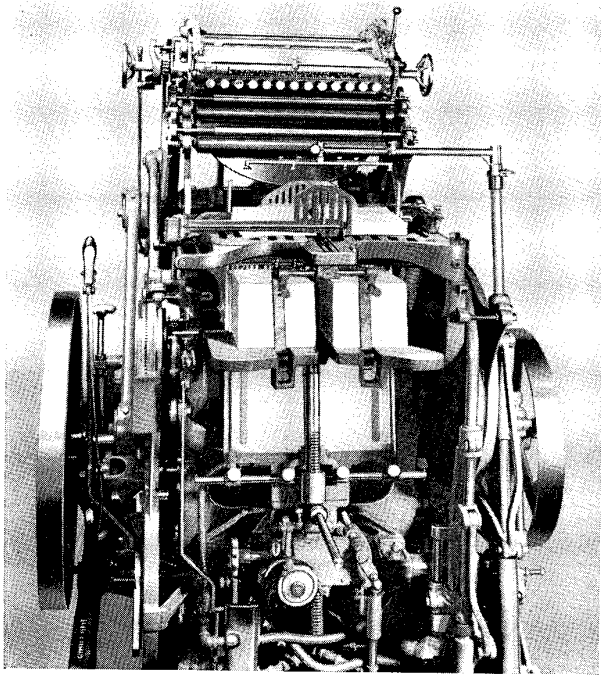

*Figure 16—Unit arranged for two-up feeding*

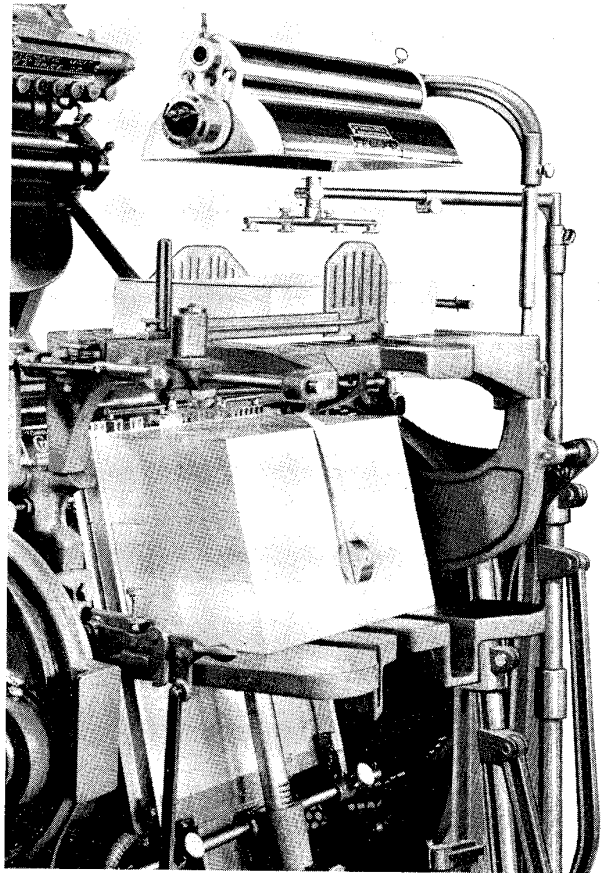

*Figure 17—Electric Sheet Dryer in position; a gas sheet dryer or portable spray equipment may also be used*

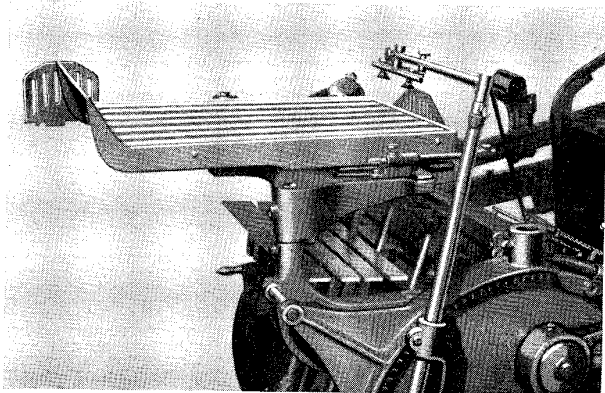

*Figure 18—Continuous delivery table available either for 10 x 15 or 12 x 18 Unit*

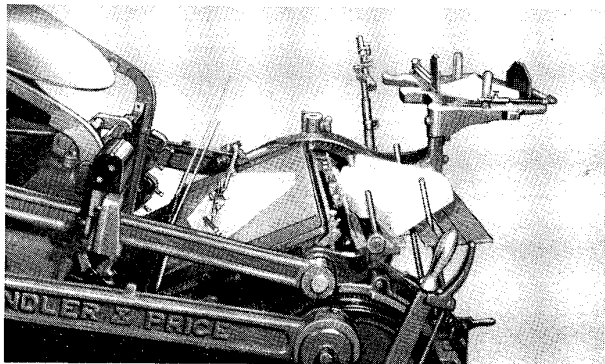

*Figure 19—Unit with special arrangement for feeding die-cut envelopes before they are folded*

# TROUBLES AND SUGGESTED METHODS OF CORRECTION

1. Improper line-up of the fountain brayer roller with the top form roller:  
Loosen the screws holding the fountain brackets to the disc bracket. The hole in the fountain bracket on the right side, facing the front of the press, is elongated to permit shifting the fountain assembly until the brayer roller lines up with the top form roller.
2. Improper line-up of the composition fountain roller with the fountain brayer roller:  
Loosen the nut on the right end of the composition roller arm shaft and turn the knurled eccentric until the correct line-up is obtained.
3. Vibrators not turning:
  - (a) Oil instead of grease is being used in the saddle roller bearings causing lack of traction of roller trucks on the bed and the extension tracks. Use grease. Keep the tracks and the trucks clean.
  - (b) Contact of the vibrator should be adjusted by means of the knurled screw of the vibrator box.
  - (c) The friction clutch on the end of the vibrator should be adjusted by turning the knurled nut at the end of the vibrator.
4. Ink disc that does not turn:  
Indicates dirt or too much oil in the clutch. Remove and clean.
5. Flywheel not running true:
  - (a) Sometimes the rough casting on the inside of the rim runs out. This cannot be corrected and other than appearance does not matter as the flywheel has been balanced.
  - (b) The key may be improperly placed (not placed according to factory marking).
  - (c) The crank shaft has been sprung in shipment.
6. Breaking of grippers:
  - (a) Caused by excessive strain due to too much packing.
  - (b) Dirt in the gripper bar slot will cause excessive strain when the gripper nut is tightened.
  - (c) The shape of the gripper has been altered. It should be changed to fit properly on the platen.
  - (d) Gripper is placed on top of platen side gauge pin.
7. Excessive noise on the impression:
  - (a) Insufficient packing for weight of form.
  - (b) Loose crankshaft pinion key.
  - (c) Bed tracks striking platen.
  - (d) Backlash between press pinion and gear.
  - (e) Improper press foundation.
8. Inability to strip sheet from the form:
  - (a) Use strings on the grippers.
  - (b) Add slight amount of reducer to ink.
  - (c) Use trip trucks or vibrators and less ink.
9. Platen seems low on one side:
  - (a) First check for faulty type or irregularities in form.
  - (b) Eccentrics out of adjustment. (For instructions on how to re-adjust eccentrics, write the factory.)
10. Press fails to throw off:
  - (a) Plugged air line.
  - (b) Dirt in the air line screens.
  - (c) Valve plunger stuck in the pulled out position.
  - (d) Valve plunger spring needs adjusting—too little tension.
11. Press continues to throw off:
  - (a) Dirt in pump valve chamber.
  - (b) Sucker tips and plugs pulled out too far.
  - (c) Valve plunger stuck in throw-off sliding bar.
  - (d) Valve plunger spring needs adjusting—too much tension.
  - (e) Too much stripper wire being used causing sheet to be pulled away from sucker tips.
12. Sheet is not being delivered:
  - (a) Suckers placed too far down on sheet.
  - (b) Suckers tipped too much in relation to the platen.
  - (c) Leaky sucker tip joints both feed and delivery.
  - (d) Sheet sticking to tympan. Cut vees in tympan near top edge of the sheet being printed to aid in lifting the sheet.
  - (e) Dirt in pump valves.
  - (f) Loose emery cloth or lumps on the suckers.
  - (g) Delivery cut-out valve stuck.
  - (h) Dirt in the screen.
13. Delivery cut-out valve not working:
  - (a) Paint, dirt or rust interfering with free movement of the plunger.
  - (b) Leak in the feed lines.
  - (c) Leak in the feed sucker tips.
  - (d) Improper positioning of stripper wires causing sheet to be pulled from feed sucker.
14. Register trouble:
  - (a) Feed table front stop not parallel to edge of platen.
  - (b) Sheet going over the lower guides.
  - (c) Improper placing of register fork.
  - (d) Sheet being fed too close to side guide.
  - (e) Feed table back stop not properly placed.

- (f) Dirt in the feed air line screen causing sheet to be pulled back from the guides.
  - (g) Angle of the register finger not the usual 15 degrees.
  - (h) Register device not working freely and easily.
  - (i) Improper tension of register finger spring.
15. Elevator raises continuously or intermittently, or not at all.
- (a) Feeler table elevator trip worn and not making proper contact with the table raising pawl.
  - (b) Sticky bearings preventing the trip from returning over the top of the pawl.
  - (c) Vertical feeler tube binding.
16. Failure of the feeder:
- (a) Center plug not in the feed head when center sucker is removed.
  - (b) Dirt in the air line screens.
  - (c) Leaky sucker tip joints.
  - (d) Improperly placed stripper wires.
  - (e) Sucker tips not placed properly in relation to the front edge of the sheet.
  - (f) Feeder valve extension out of the hole.
  - (g) Dirt in the pump valve.
  - (h) Sucker head plugs not in far enough.
17. Feeder picking more than one sheet:
- (a) Porous stock.
  - (b) Pile height not correct.
  - (c) Blast improperly adjusted.
  - (d) Stripper wires set at the wrong height.
18. Feeder valve jumping:  
Muffler plugged, causing the plunger to dance and open the feeder valve.
19. Chattering feed and delivery slides:
- (a) Wrong kind of oil being used.
  - (b) Dirt on the slides.
20. Pump troubles:
- (a) If the pump crank bearing is noisy, remove the cap and take out a part of the laminated shim.
  - (b) If the top of pump is noisy, tighten stuffing box gland by hand.
  - (c) If blast is coming through feed or delivery lines it indicates pump valve is stuck.
  - (d) A periodic cleaning of pump valve is recommended to remove paper dust and lint.
21. Slurring: Slurring a part of a rule form may be caused by a number of conditions such as:
- (a) Spring or bulge in the form.
  - (b) A wrinkled or baggy tympan.
  - (c) Curly or warped stock.
  - (d) Too soft packing.
- These cause the sheet to touch the form prematurely and then slur into position. Each form represents a separate problem. It is necessary to study the cause of the slur and then remedy it before starting to print the job.
- A few remedies for slurring:
- (a) The form must be locked firmly and planed level with no spring or bulge.
  - (b) Use a hard packing: 5 sheet 50-lb. S & S C Book, one pressboard postcard stock thickness, and a good tympan top sheet. The packing should total .035" or more.
  - (c) If the stock is curly or warped, use strings and corks to help level the sheet before the form strikes the paper. By dropping a piece of tag board from the strings or the grippers between the rules that are slurring and then gluing corks on the tag board, it should be possible to overcome the slurring of the forms.
  - (d) Old or hard form rollers will also give a wiping or skidding slur at times. The bed tracks should also be free from oil or grease or the roller trucks will skid and give a wiping slur.
  - (e) On box rule forms slurring can be overcome sometimes by drilling through the side of the rule with a No. 50 drill. The holes should be spaced about 2" apart. This releases the air pocket caused by a close box rule.

## NOTES

# INDEX

	Page		Page
Air Line Screens . . . . .	9	Jogger . . . . .	22
Blast . . . . .	21	Leveling Press . . . . .	7
Card Feeding (No. 88) . . . . .	23	Lock-Up . . . . .	15
Controls . . . . .	20	Lubrication . . . . .	7, 9
Delivery Bar . . . . .	12-19	Metal Sucker Tips . . . . .	17, 19
Delivery Table . . . . .	22	Operating Sequence . . . . .	13
Delivery Table (Continuous) . . . . .	25, 26	Packing . . . . .	9, 15
Die Cutting . . . . .	25	Paper Bag Feeding . . . . .	25
Dummy Sucker . . . . .	16, 17	Parts Ordering . . . . .	6
Electrical Wiring . . . . .	7	Pile Height Regulator . . . . .	21, 25
Emery Discs . . . . .	19	Register Bracket . . . . .	18, 19, 24
Envelope Feeding . . . . .	23, 24, 25	Register Finger . . . . .	15, 16, 18
Envelope Feeding (Died Out) . . . . .	25, 26	Rubber Suckers . . . . .	17, 19
Feed Bar . . . . .	12, 16, 17	Saddle Lifter . . . . .	22
Feed Table . . . . .	15, 20, 21	Sheet Control Finger (Feed) . . . . .	23
Folders (Delivering) . . . . .	25	Sheet Location . . . . .	14, 15
Foundations . . . . .	7	Specifications . . . . .	5
Fountains . . . . .	10, 11, 13	Speeds . . . . .	5, 9
Gauge Pins . . . . .	15, 16	Stripper Wires . . . . .	19
Grippers . . . . .	15	Tag Feeding . . . . .	25
Grippers (Extension) . . . . .	22	Tracks, Adjustable Bed . . . . .	10, 11
Hand Feeding . . . . .	12, 13	Tracks, Extension Roller . . . . .	10, 11
Hold Down Device . . . . .	23	Trip Trucks . . . . .	23
Impression Control . . . . .	8, 9, 11, 15	Troubles . . . . .	27, 28
Ink Disc (Reversible) . . . . .	10, 11	Two-Up Attachment . . . . .	24, 26
Ink Drying Attachments . . . . .	25, 26	Tympan Bale Lifter . . . . .	22
Installation . . . . .	7	Vibrators . . . . .	22

---

**THE CHANDLER & PRICE COMPANY**

CLEVELAND, OHIO

